

# ***NIR-BORESCOPE-656 & NIR-BORESCOPE-2K***

THERMAL IMAGING SOLUTIONS

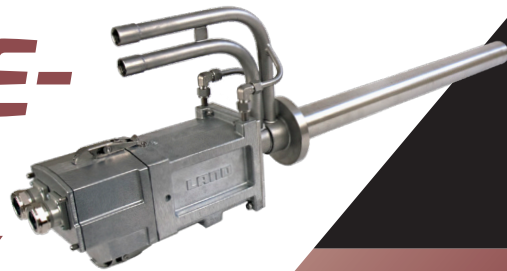

① 600 to 1800 °C / 1112 to 3272 °F

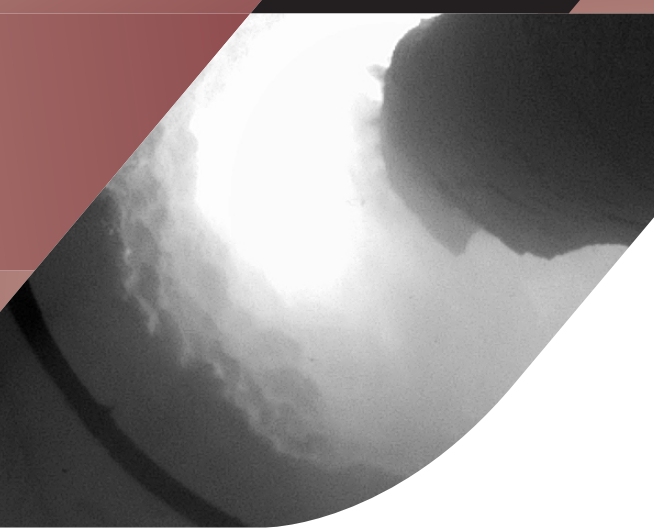

**LAND**  
**AMETEK**<sup>®</sup>  
PROCESS & ANALYTICAL INSTRUMENTS



QUALITY CUSTOMER SOLUTIONS

# NIR-BORESCOPE-656 & NIR-BORESCOPE-2K

## THERMAL IMAGING SOLUTIONS

**AMETEK LAND HAS BEEN BUILDING PRECISION MEASURING EQUIPMENT SINCE 1947.**

We are specialists in non-contact temperature measurement and combustion monitoring with our products finding applications across diverse industries such as steel and glass making, power generation and cement manufacture.

As part of AMETEK Process & Analytical Instruments Division since 2006, our customers benefit from the worldwide AMETEK sales and service team.

The NIR-BoreScope-656 (NIR-B-656) and NIR-BoreScope-2K (NIR-B-2K) are high resolution short wavelength full radiometric infrared borescope imaging cameras, designed to produce continuous live high definition thermal images, at an outstanding pixels resolution of up to 3 million pixels. The cameras can measure temperatures in the range of 600 to 1800 °C (1112 to 3272 °F) and are suitable for a wide range of continuous process monitoring and controlling applications providing high resolution images and temperature readings in large furnaces.

By providing a cutting-edge clear thermal image unaffected by the furnace hot atmosphere/gases, the NIR-B-656 allows operators to measure from any of the 322,752 pixels, or 2,904,768 pixels for the NIR-B-2K, and optimise furnace temperature to save energy, increase efficiency and reduce emissions.

With 24/7 coverage via Gigabit Ethernet connection, automated alarm outputs instantly

alert the user to any problems or structural issues to ensure furnace efficiency and have complete operational control. Plus thermal anomalies are easy to detect, through continuous monitoring of all positions from the safety of the control room.

The cameras require only a narrow opening to accommodate a wide field-of-view angle lens tip, a choice of optics (FOVs) are available and provide an extensive measurement area throughout for wide furnace coverage.

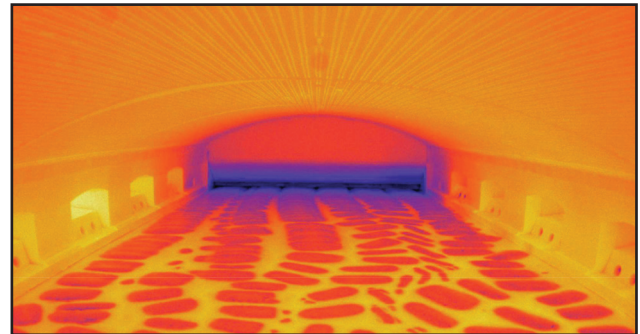

A high resolution view into a large glass melt tank furnace.

### FIELD OF VIEW OPTICS

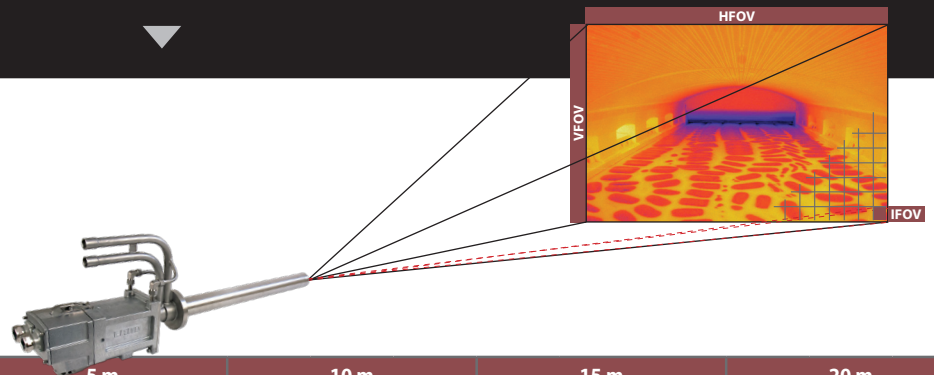

	Distance	1 m			5 m			10 m			15 m			20 m		
		HFOV x VFOV	Width	Height	IFOV (center)	Width	Height	IFOV (center)	Width	Height	IFOV (center)	Width	Height	IFOV (center)	Width	Height
<b>NIR-B-2K</b>	95° x 71°	2.1 m	1.4 m	0.84 mm	10.9 m	7.1 m	4.2 mm	21.8 m	14.2 m	8.4 mm	32.7 m	21.3 m	12.6 mm	43.6 m	28.5 m	16.8 mm
<b>NIR-B-656</b>	95° x 71°	2.1 m	1.4 m	2.5 mm	10.9 m	7.1 m	12.6 mm	21.8 m	14.2 m	25.2 mm	32.7 m	21.3 m	37.8 mm	43.6 m	28.5 m	50.4 mm
	31° x 24°	0.57 m	0.43 m	0.84 mm	2.87 m	2.13 m	4.2 mm	5.73 m	4.25 m	8.4 mm	8.60 m	6.38 m	12.6 mm	11.47 m	8.50 m	16.8 mm

## NIR-BORESCOPE-656 & NIR-BORESCOPE-2K

# SPECIFICATION & DESIGN

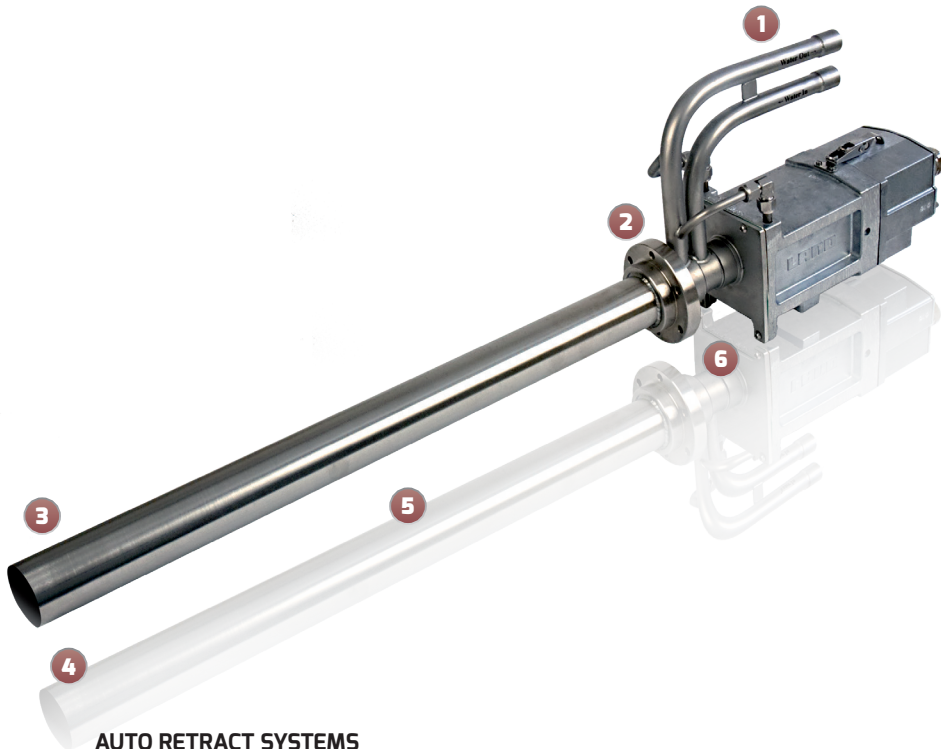

## 1: HIGH PERFORMANCE WATER COOLING SYSTEM

The low water flow requirements for camera cooling, even in the highest temperature furnaces, equal low running costs

## 2: RANGE OF MOUNTING OPTIONS

The most common mounting options available to ensure simple installation

## 3: THERMOCOUPLE AT CAMERA OPTIC TIP

Giving the operator an alarm for removing the instrument preventing damage if maximum temperatures are exceeded

## 4: VIEWING ANGLE

Wide angle optics provide a full furnace or tank internal thermal view. Up to 1968x1476 resolution gives nearly 3 million pixels data points

## 5: PROBE LENGTHS

The range of the probe lengths create the best fit for every installation

## 6: INTEGRATED AIR PURGE

Air purge design maintains a dust-free optical system while consuming minimal instrument air

## AUTO RETRACT SYSTEMS

Designed to auto-retract and protect the thermal imager from damage by overheating in the event of loss of water flow, air pressure, electricity supply or high borescope tip temperature alarm.



## TYPICAL APPLICATIONS

Reheat Furnaces

Glass Melt Furnaces

Cement Kilns

Biomass Boilers

Coal Fired Power Boilers

## FEATURES & BENEFITS

### 24/7 FURNACE MONITORING

Continuously monitor the temperature of furnace heating, refractory areas and stock.

### CHOICE OF WIDE ANGLE OPTICS AND PIXEL RESOLUTIONS

Monitor a very wide range of stock, refractories and burner/heating zones in just one thermal image.

### HIGHLY ACCURATE TEMPERATURE READING

High-performance system calibration of each camera pixel, with a temperature reading of better than +/- 1%, and an outstanding homogeneity across the whole thermal image, including edges.

### ADVANCED IMAGE PROCESSING SOFTWARE

IMAGEViewer and IMAGEPro utilities to control, monitor, analyse and capture

data from thermal imaging camera.

### ADVANCED FILTERING

Advanced spectral filtering is unaffected by the hot furnace atmosphere or/ and gases to deliver real temperature readings and clear monitoring from furnace interior.

### RELIABLE & SAFE SYSTEM OPERATION

Designed for harsh and high temperature environmental conditions, plus a range of auto-retraction systems are available to protect against overheating in case of a water cooling and/or air purging loss.

### PATENTED BACKGROUND COMPENSATION

Corrects the effect of background reflection online and continuously enables correct stock temperature reading.

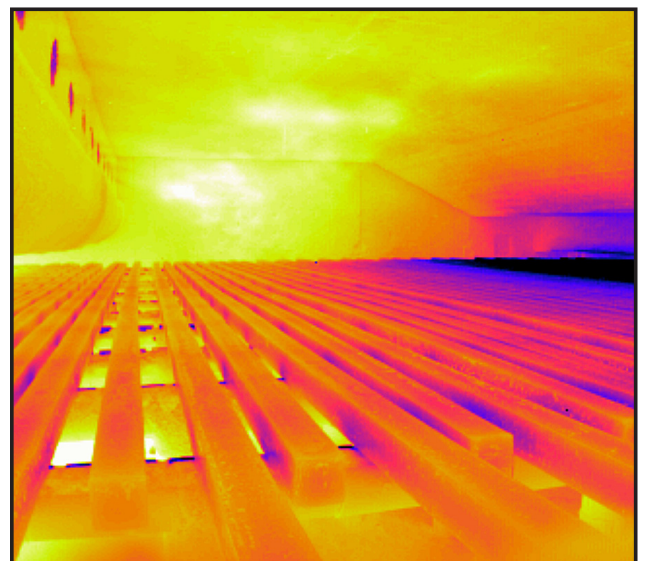

# NIR-BOREScope-656 & NIR-BOREScope-2K

THERMAL IMAGING SOLUTIONS

## SPECIFICATIONS

	NIR-B-656	NIR-B-2K
<b>CAMERA UNIT</b>		
Measurement Range:	600 - 1000 °C / 1112 - 1832 °F 800 - 1400 °C / 1472 - 2552 °F 1000 - 1800 °C / 1832 - 3272 °F	
Pixel Resolution:	656x492	1968x1476
Spectral Response:	1 µm	
Frame Rate:	30 fps	15 fps
Detector:	FPA - Semiconductor	
Optic (HFOV x VFOV):	31° x 24° / 95° x 71°	95° x 71°
Optic (IFOV):	2.53 mrad (95° x 71°) / 0.84 mrad (31° x 24°)	0.84 mrad (95° x 71°)
Focus Range:	1 m to infinity	
Probe Diameter:	Ø 61mm / Ø 2.4"	
Probe Lengths:	305, 610 or 915 mm (12", 24" or 36")	
Mountings:	Choice of 3" ANSI 150 RF Flange & Gasket or PN16 DN80 Flange & Gasket with a 12" standpipe	
Protection Window:	Sapphire	
Accuracy:	1% of reading (K)	
Repeatability:	1 K	
Dimensions:	254 x 560 x 810 mm* (* or 1120 or 1420 mm); 10 x 22 x 32 in** (** or 44 or 56 in)	
Power Rating:	24 V DC, 4W	
Weight:	15 kg / 33.07 lbs (for 24" variant)	
Environmental Rating:	IP65 / NEMA 4	
<b>CAMERA SUPPLY</b>		
Connections:	Gbit Ethernet; Local connection interface between camera unit and image processing system	
Service:	Water, instrument air, power input, located to the rear of the enclosure	
<b>POWER SUPPLY UNIT (PSU)</b>		
Components:	Power supply, Ethernet communications (switch), Fibre optic data connection (option)	
IP Rating:	IP65 / NEMA 4	
Size:	380 x 380 x 211 mm / 15" x 15" x 8.3"	
Weight:	15 kg (33.07 lbs)	
UL Approval:	Listed to UL508A & CSA-C22.2 No. File Number E499440	
<b>IMAGE PROCESSING</b>		
Software:	IMAGEViewer & IMAGEPro Advanced Image Processing and Controlling Software	
Workstation:	PC - Workstation (option)	
Interfacing:	Open Data Interface, Modbus TCP, Moxa I/O unit	
<b>ACCESSORIES</b>		
Optional Accessories:	Power supply, cables, water-cooled/purged mounting and tube, software, workstation, auto-retraction systems	

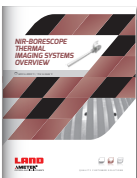

NIR-BOREScope  
THERMAL IMAGING  
SYSTEMS OVERVIEW



NIR-B-640



NIR-B-640-EX  
FORMERLY: NIR-BOREScope-3XR

DISCOVER HOW OUR BROAD RANGE OF  
NON-CONTACT TEMPERATURE  
MEASUREMENT AND COMBUSTION  
& EMISSIONS PRODUCTS OFFER A  
SOLUTION FOR YOUR PROCESS

WWW.AMETEK-LAND.COM

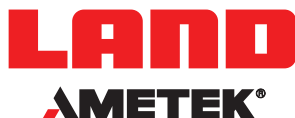

### CONTACT US



[www.ametek-land.com](http://www.ametek-land.com)



[land.enquiry@ametec.com](mailto:land.enquiry@ametec.com)



Certificate No. CC-2041  
APPLIES IN INDIA



Certificate No. 129372  
APPLIES IN THE UK



APPLIES IN THE US